



Universal Oven UF160

Precise drying, heating, ageing, burn-in and hardening in research, science, industry and quality assurance.



The universally applicable lab oven U is Memmert's classic appliance for temperature control in science, research and material tests in industry. The technologically perfected masterpiece made of high-quality, hygienic, easy-to-clean stainless steel leaves nothing to be desired in terms of ventilation and control technology, overtemperature protection and precisely tuned heating technology. On this page, you can find all the essential technical data on the universal Memmert lab oven. Our customer relations team will be pleased to help if you want further information.

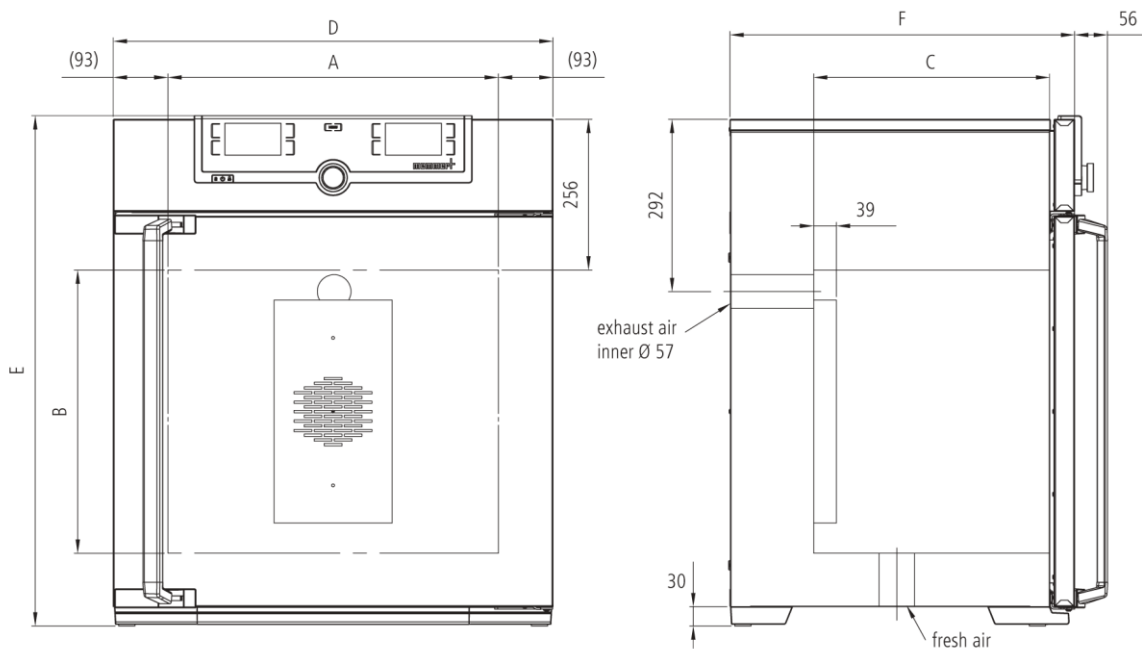

Control of standard components

Control COCKPIT	adaptive multifunctional digital PID-microprocessor controller with high-definition TFT-color display
Temperature	1 Pt100 sensor DIN class A in 4-wire-circuit
Timer	Digital backwards counter with target time setting, adjustable from 1 minute to 99 days

Temperature

Set temperature range in °C	min.10°C above ambient up to +300°C
	resolution of display for setpoint values 0.1°C up to 99.9°C, 0.5°C from 100°C and for actual values 0.1°C (LED)

Control technology

adjustable parameters	temperature (Celsius or Fahrenheit), fan speed, air flap position, program time, time zones, daylight savings time
Function Setpoint WAIT	the process time does not start until the set temperature is reached
Language setting	German/English/Spanish/French
Calibration	three freely selectable temperature values

Ventilation

Fan	forced air circulation by quiet air turbine, adjustable in 10 % steps
Fresh air admixture	adjustment of pre-heated fresh air admixture by air flap control in 10 % steps
Vent	vent connection with restrictor flap

Communication

Programming	AtmoCONTROL software for reading out, managing and organizing the data logger via Ethernet interface (temporary trial version can be downloaded). USB stick with AtmoCONTROL software available as accessory (on demand).
Documentation	program stored in case of power failure

Safety

Temperature control	adjustable electronic overtemperature monitor and mechanical temperature limiter TB, protection class 1 according to DIN 12880 to switch off the heating approx. 20°C above nominal temperature
Autodiagnostic system	for fault analysis

Standard equipment

Door	fully insulated stainless steel door with 2-point locking (compression door lock)
Internals	2 stainless steel grids
Scope of delivery	incl. works calibration certificate for +160°C
Housing	rear zinc-plated steel
Interior	easy-to-clean interior, made of stainless steel, reinforced by deep drawn ribbing with integrated and protected large-area heating on four sides

Stainless steel interior

$w_{(A)} \times h_{(B)} \times d_{(C)}$: 22" x 28.4" x 15.8"

Volume 161 l

Max. loading of chamber: 462 lbs

Textured stainless steel casing

$w_{(D)} \times h_{(E)} \times d_{(F)}$: 29.3" x 43.6" x 23"

Electrical data

230 V (+ / - 10%), 50/60 Hz / 13.9 amps

115 V (+ / - 10%), 50/60 Hz / 19.1 amps

Packing/shipping data

the appliances must be transported upright

Customs tariff number 8419 8998

Country of origin Federal Republic of Germany

WEEE-Reg.-No. DE 66812464

Dimensions approx. incl. carton W x H x D: 32.7" x 51.2" x 31.5"

Net weight approx. 212 lbs

Gross weight carton approx. 269 lbs

Standard units are safety-approved and bear the test marks

